

**COLLECTION 2020**  
**SPECIFICATION BOOKLET**

**Psalt.**

**AWARD WINNING STUDIO CREATING EXCITING  
PRODUCTS FOR INTERESTING SPACES.**

## PSALT DESIGN - IT'S A SILENT 'P'.

### ABOUT

*Psalt Design is an award-winning creative studio which designs & manufactures design led furniture & interior products with a focus on concept, material & process. Formed in 2010 by Richard Bell, the company manufactures high quality & contemporary products, for domestic & commercial spaces, which are manufactured in Great Britain.*

### VISION

*Our vision is to create exciting and unique products for interesting brands and spaces around the globe. We aim to produce timeless and customisable pieces which are manufactured responsibly by the best craftsmen in the UK.*

### CLIENTS

*Nando's  
ProperCorn  
Residence Inn by Marriott  
AllStay Apartments  
WeWork  
Campus Living Villages UK  
Chatsworth Estate  
Historic England*



**PRODUCT**  
**MYOSOTIS NOTICE BOARD**

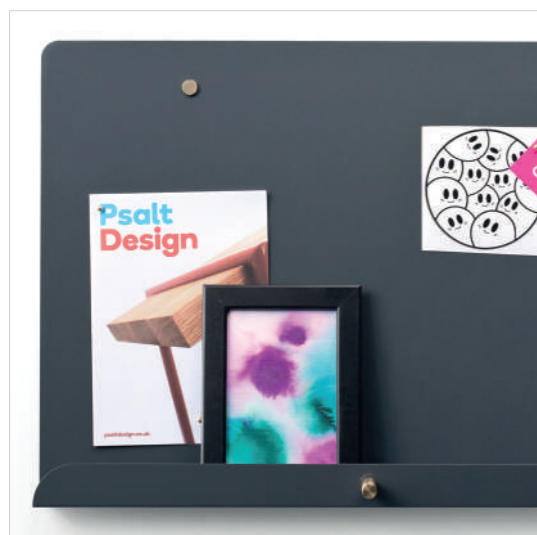
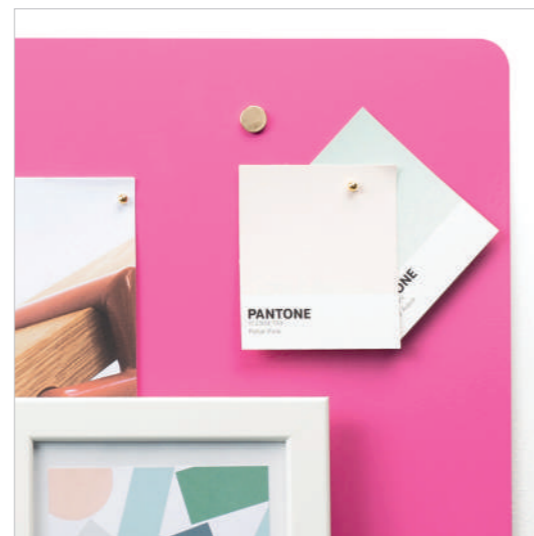
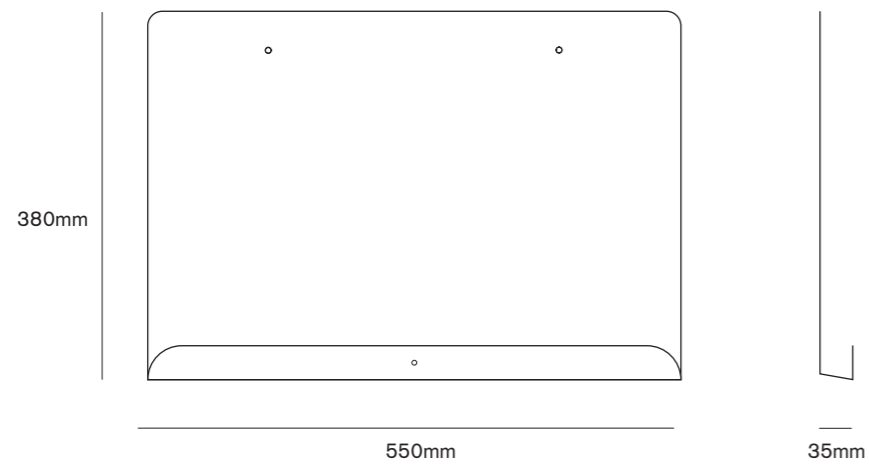

**COLLECTION 2020**  
**SPECIFICATION BOOKLET**

**PRODUCT**  
**MYOSOTIS NOTICE BOARD**

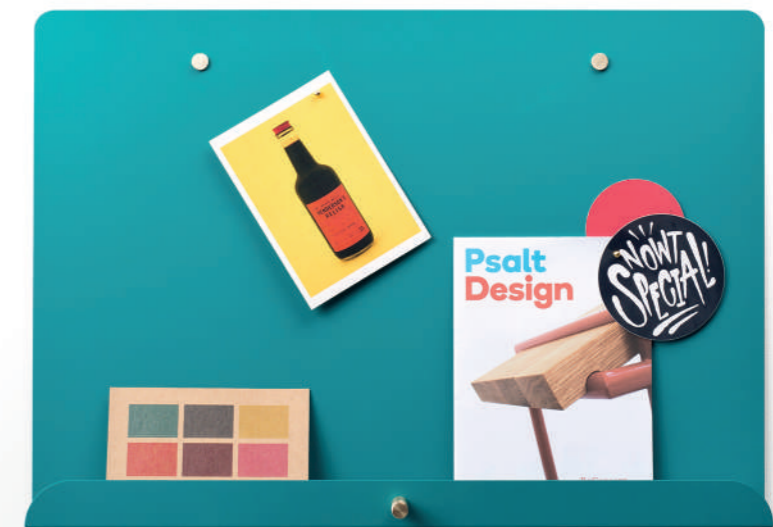

**PRODUCT INFORMATION**

**DIMENSIONS (MM)**  
W550 x H380 x D35

**WEIGHT (KG)**  
2 (approx)

**MATERIALS**  
Sheet Steel  
Brass

**NOTE**  
\*Custom orders may be subject to a minimum quantity order. Please contact us to discuss.

**OPTIONS**

**COLOURS**

	<b>Water Blue (RAL 5021)</b>	<b>MYO-STD-WB</b>
	<b>Volcanic Black (RAL 9017)</b>	<b>MYO-STD-VB</b>
	<b>Porcelain White (RAL 9016)</b>	<b>MYO-STD-PW</b>
	<b>Graphite Grey (RAL 7024)</b>	<b>MYO-STD-GG</b>
	<b>Coral Reef (RAL 3022)</b>	<b>MYO-STD-CR</b>
	<b>Midnight Navy (RAL 5022)</b>	<b>MYO-STD-MN</b>
	<b>LDF Red (RAL 3020)</b>	<b>MYO-STD-LDF</b>
	<b>Lemon Yellow (RAL 1012)</b>	<b>MYO-STD-LY</b>
	<b>Purple Red (RAL 3004)</b>	<b>MYO-STD-PR</b>
	<b>Heather Violet (RAL 4003)</b>	<b>MYO-STD-HV</b>
	<b>Custom RAL</b>	<b>MYO-STD-CUS</b>

**PRODUCT**  
**MYOSOTIS GRANDE NOTICE BOARD**

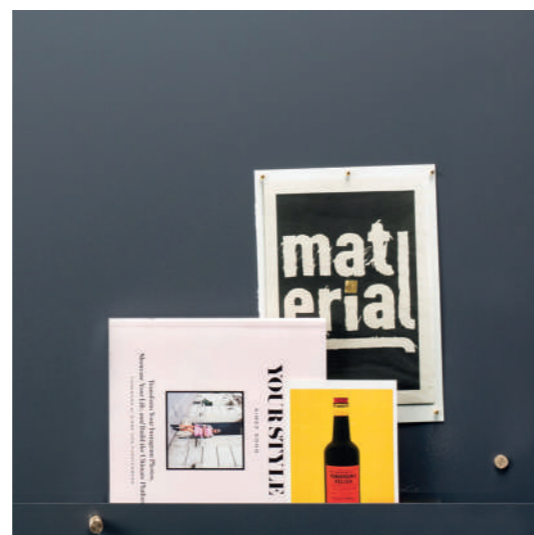
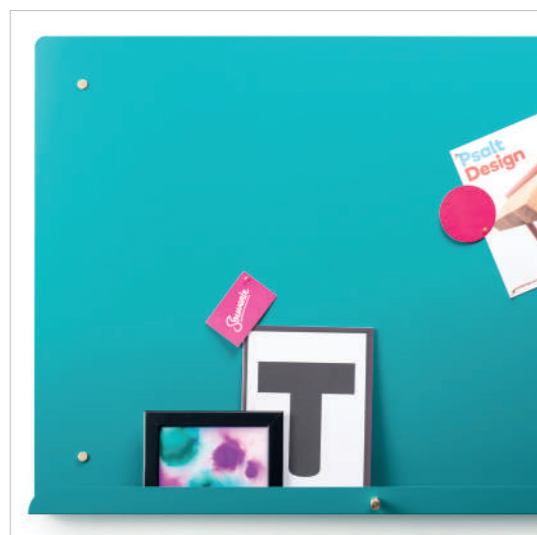
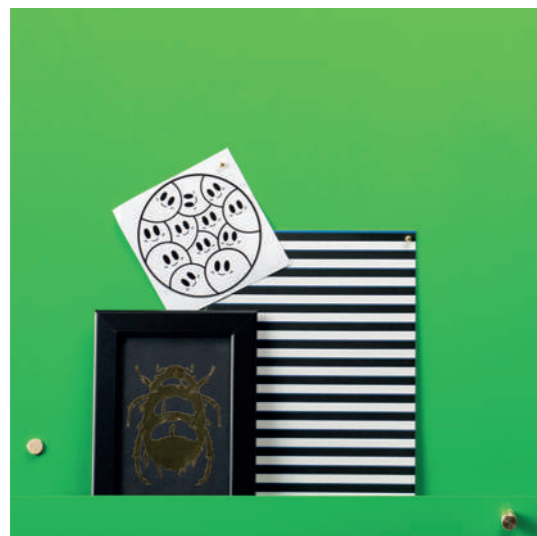
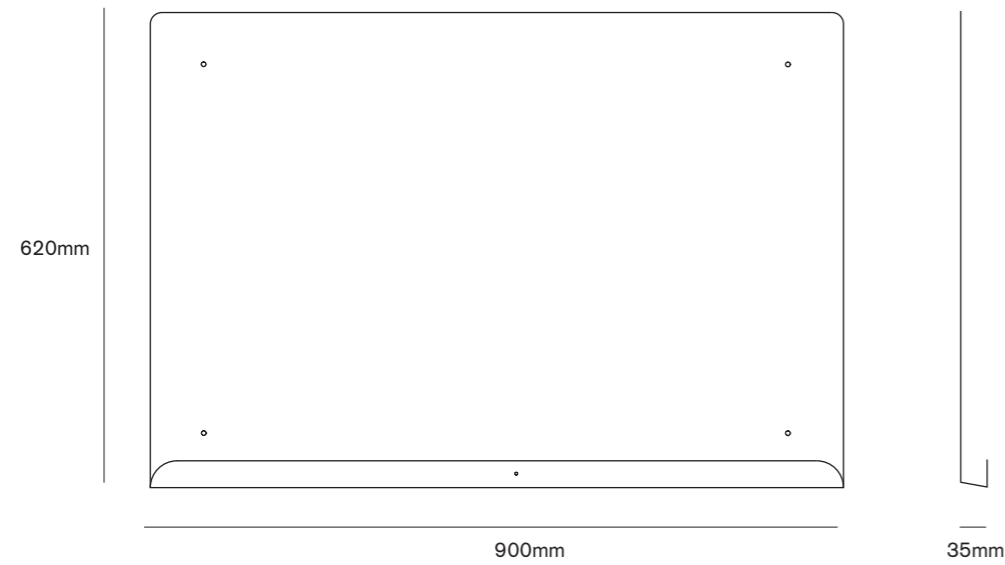

**COLLECTION 2020**  
**SPECIFICATION BOOKLET**

**PRODUCT**  
**MYOSOTIS GRANDE NOTICE BOARD**

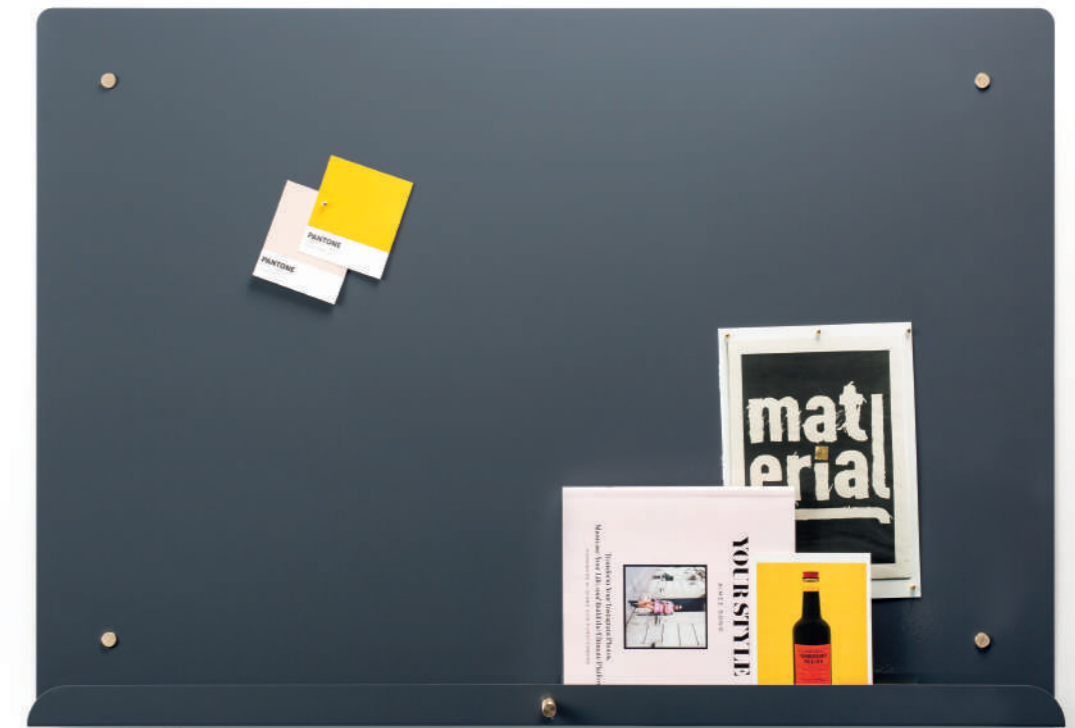

**PRODUCT INFORMATION**

**DIMENSIONS (MM)**  
W900 x H620 x D35

**WEIGHT (KG)**  
6 (approx)

**MATERIALS**  
Sheet Steel  
Brass

**NOTE**  
\*Custom orders may be subject to a minimum quantity order. Please contact us to discuss.

**OPTIONS**

**COLOURS**

- Water Blue (RAL 5021)** **MYO-GRA-WB**
- Volcanic Black (RAL 9017)** **MYO-GRA-VB**
- Porcelain White (RAL 9016)** **MYO-GRA-PW**
- Graphite Grey (RAL 7024)** **MYO-GRA-GG**
- Coral Reef (RAL 3022)** **MYO-GRA-CR**
- Midnight Navy (RAL 5022)** **MYO-GRA-MN**
- LDF Red (RAL 3020)** **MYO-GRA-LDF**
- Lemon Yellow (RAL 1012)** **MYO-GRA-LY**
- Purple Red (RAL 3004)** **MYO-GRA-PR**
- Heather Violet (RAL 4003)** **MYO-GRA-HV**
- Custom RAL** **MYO-GRA-CUS**

**PRODUCT**  
**MYOSOTIS XL NOTICE BOARD**

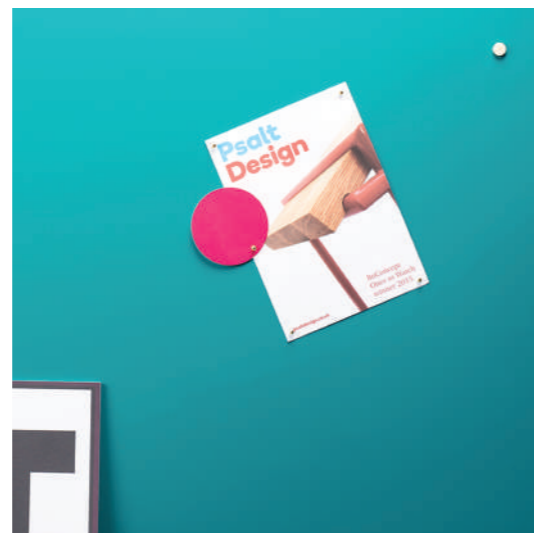
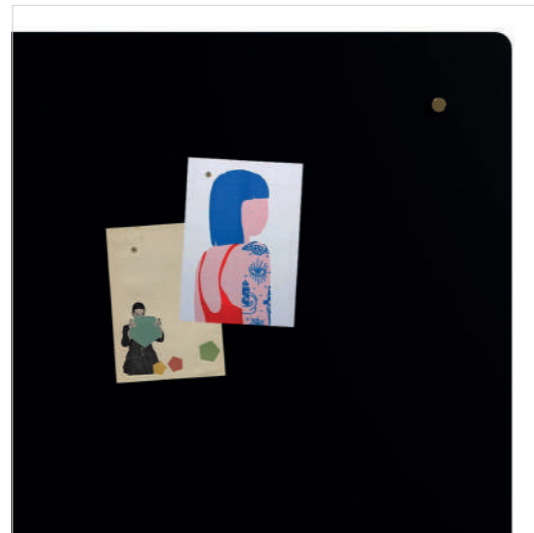
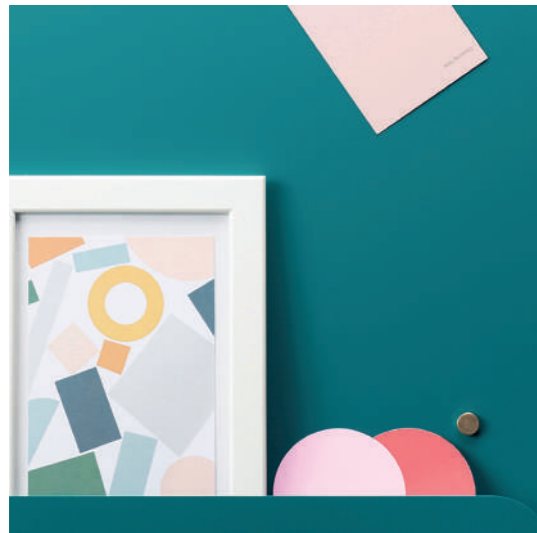
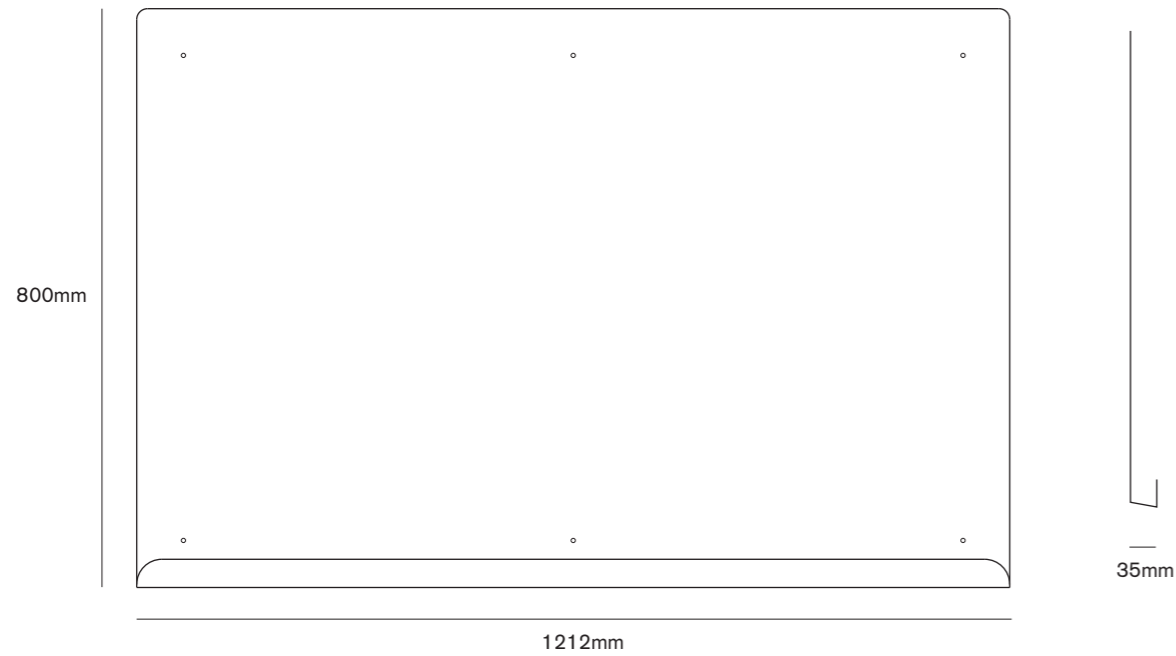

**COLLECTION 2020**  
**SPECIFICATION BOOKLET**

**PRODUCT**  
**MYOSOTIS XL NOTICE BOARD**

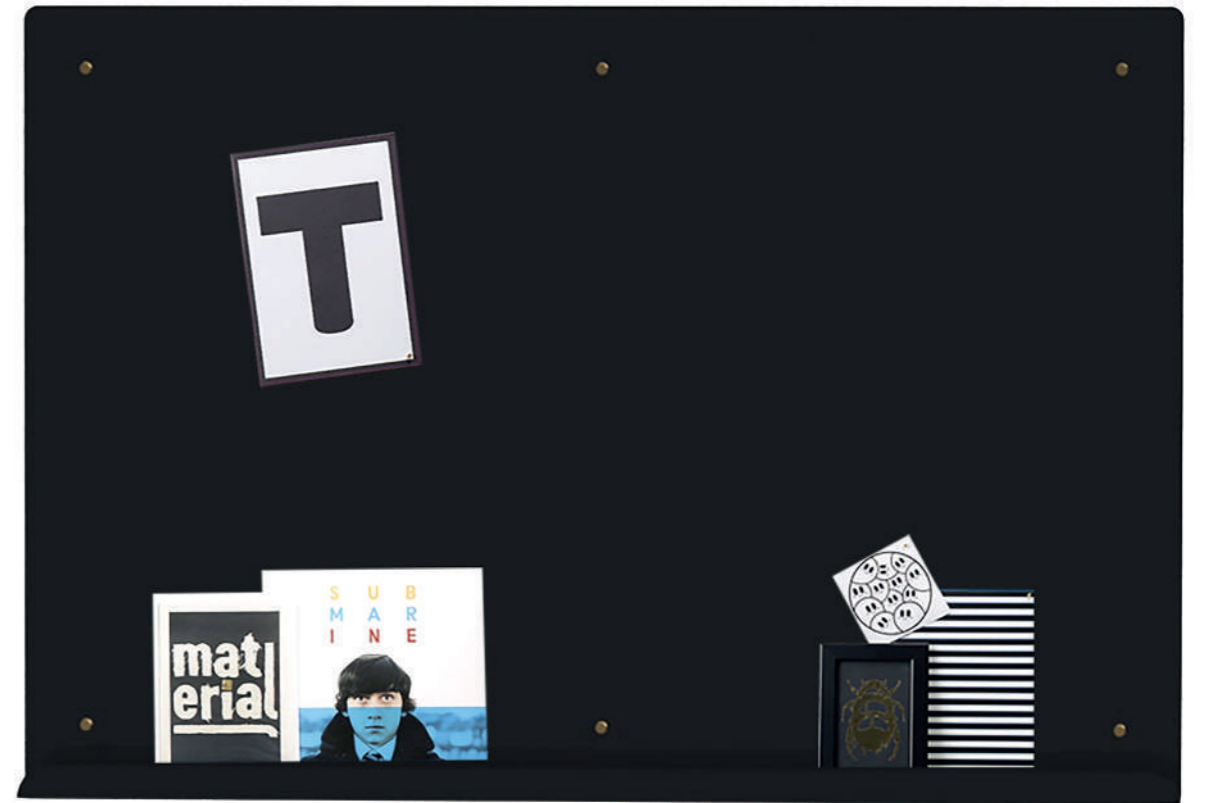

**PRODUCT INFORMATION**

**DIMENSIONS (MM)**  
W1212 x H800 x D35

**WEIGHT (KG)**  
9 (approx)

**MATERIALS**  
Sheet Steel  
Brass

**NOTE**  
\*Custom orders may be subject to a minimum quantity order. Please contact us to discuss.

**OPTIONS**

**COLOURS**

- Water Blue (RAL 5021) **MYO-XL-WB**
- Volcanic Black (RAL 9017) **MYO-XL-VB**
- Porcelain White (RAL 9016) **MYO-XL-PW**
- Custom RAL **MYO-XL-CUST**

**CODE**

**PRODUCT**  
**MYOSOTIS PORTRAIT NOTICE BOARD**

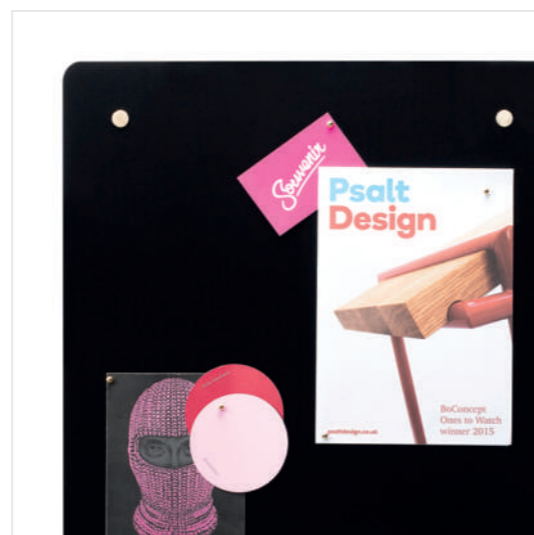
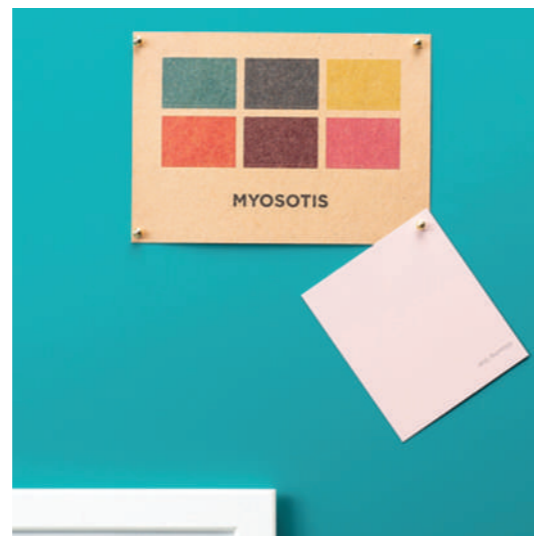
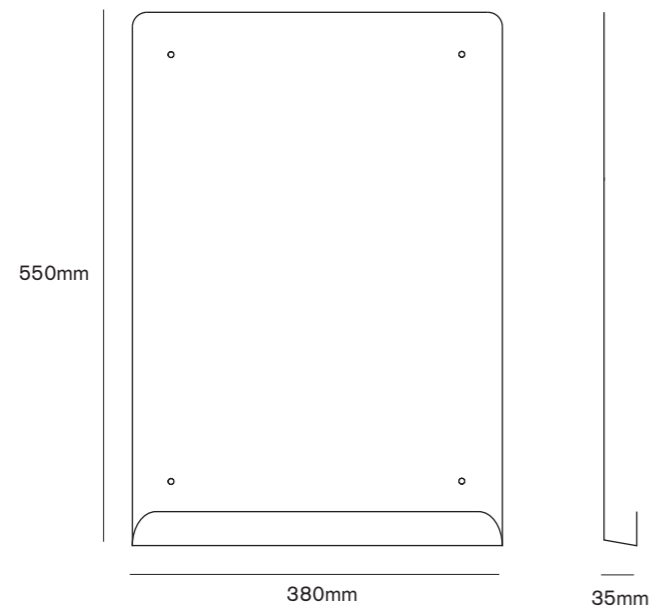

**COLLECTION 2020**  
**SPECIFICATION BOOKLET**

**PRODUCT**  
**MYOSOTIS PORTRAIT NOTICE BOARD**



**PRODUCT INFORMATION**

**DIMENSIONS (MM)**  
W380 x H550 x D35

**WEIGHT (KG)**  
2 (approx)

**MATERIALS**  
Sheet Steel  
Brass

**NOTE**  
\*Custom orders may be subject to a minimum quantity order. Please contact us to discuss.

**OPTIONS**

**COLOURS**

- |   |                                   |                    |
|---|-----------------------------------|--------------------|
|  | <b>Water Blue (RAL 5021)</b>      | <b>MYO-POR-WB</b>  |
|  | <b>Volcanic Black (RAL 9017)</b>  | <b>MYO-POR-VB</b>  |
|  | <b>Porcelain White (RAL 9016)</b> | <b>MYO-POR-LDF</b> |
|  | <b>Graphite Grey (RAL 7024)</b>   | <b>MYO-POR-GG</b>  |
|  | <b>Coral Reef (RAL 3022)</b>      | <b>MYO-POR-CR</b>  |
|  | <b>Midnight Navy (RAL 5022)</b>   | <b>MYO-POR-MN</b>  |
|  | <b>Custom RAL</b>                 | <b>MYO-POR-CUS</b> |

**PRODUCT  
MAGPIE SHELIVING**

**COLLECTION 2020  
SPECIFICATION BOOKLET**

**PRODUCT  
MAGPIE SHELIVING**

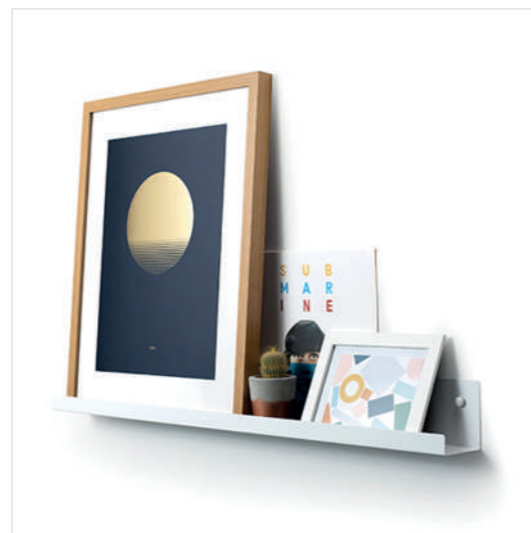
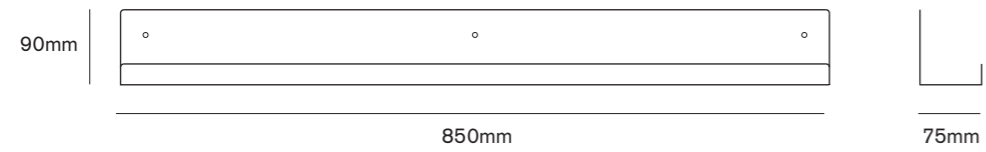

**PRODUCT INFORMATION**

**OPTIONS**

**CODE**

**DIMENSIONS (MM)**  
W850 x H90 x D75

**WEIGHT (KG)**  
3 (approx)

**MATERIALS**  
Sheet Steel

**COLOURS**

● Traffic Black (RAL 9017)

○ Traffic White (RAL 9016)

● Custom RAL

**MAG-ST-TB**

**MAG-ST-TW**

**MAG-ST-CUS**

**NOTE**

\*Custom orders may be subject to a minimum quantity order. Please contact us to discuss.

**PRODUCT**  
**MAGPIE SHELIVING LARGE**

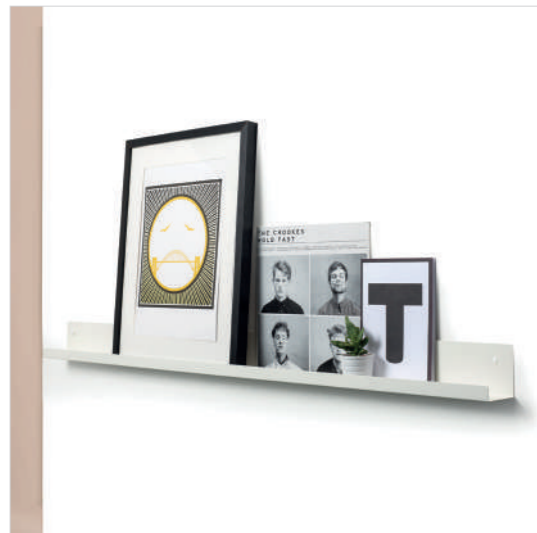
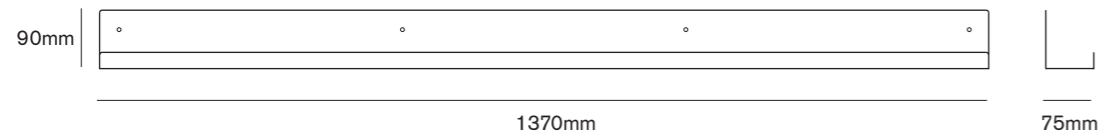

**COLLECTION 2020**  
**SPECIFICATION BOOKLET**

**PRODUCT**  
**MAGPIE SHELIVING LARGE**



**PRODUCT INFORMATION**

**DIMENSIONS (MM)**  
W1370 x H90 x D75

**WEIGHT (KG)**  
5 (approx)

**MATERIALS**  
Sheet Steel

**NOTE**  
\*Custom orders may be subject to a minimum quantity order. Please contact us to discuss.

**OPTIONS**

**COLOURS**

-  Traffic Black (RAL 9017)
-  Traffic White (RAL 9016)
-  Custom RAL

**CODE**

- MAG-LA-TB**
- MAG-LA-TW**
- MAG-LA-CUS**



**PRODUCT  
ADORN SHELVING**

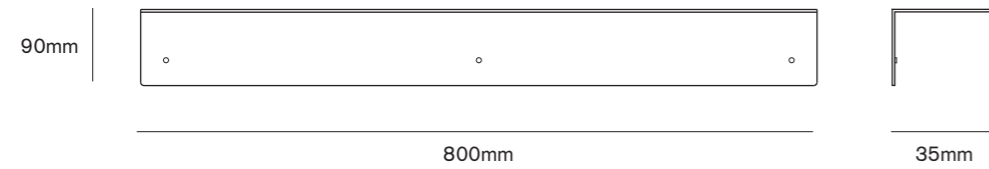

**COLLECTION 2020  
SPECIFICATION BOOKLET**

**PRODUCT  
ADORN SHELVING**



**PRODUCT INFORMATION**

**DIMENSIONS (MM)**  
W800 x H90 x D120

**WEIGHT (KG)**  
2 (approx)

**MATERIALS**  
Aluminium

**NOTE**  
\*Custom orders may be subject to a minimum quantity order. Please contact us to discuss.

**OPTIONS**

**COLOURS**

- Traffic Black (RAL 9017)
- Traffic White (RAL 9016)
- Custom RAL

**CODE**

- ADORN-TB
- ADORN-TW
- ADORN-CUS

**PRODUCT**  
**HARPA MIRROR STANDARD**

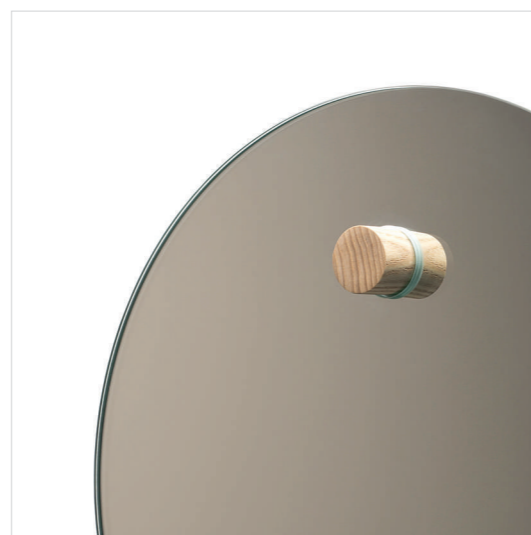
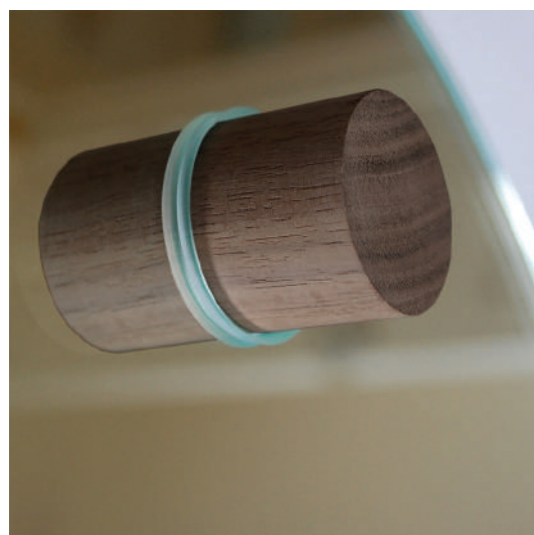
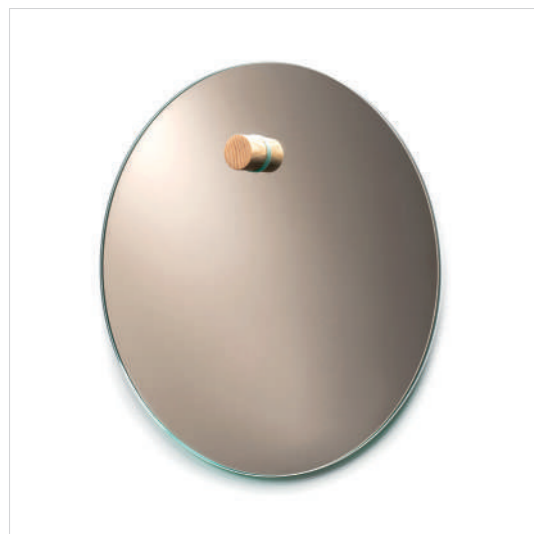
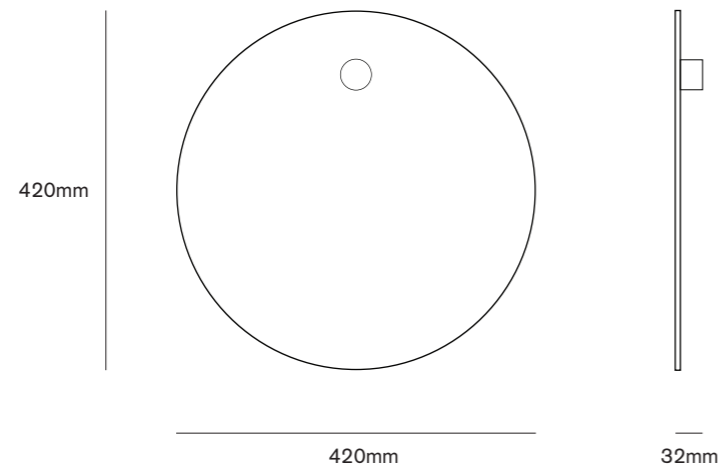

**COLLECTION 2020**  
**SPECIFICATION BOOKLET**

**PRODUCT**  
**HARPA MIRROR STANDARD**



**PRODUCT INFORMATION**

**DIMENSIONS (MM)**  
W420 x H420 x D32

**WEIGHT (KG)**  
2 (approx)

**MATERIALS**  
Mirrored Glass  
Ash/Walnut Dowel

**NOTE**  
\*Custom orders may be subject to a minimum quantity order. Please contact us to discuss.

**OPTIONS**

**FINISH**

- Ash
- Walnut

**CODE**

**HAR-ST-ASH**  
**HAR-ST-WAL**

**PRODUCT**  
**HARPA MIRROR LARGE**

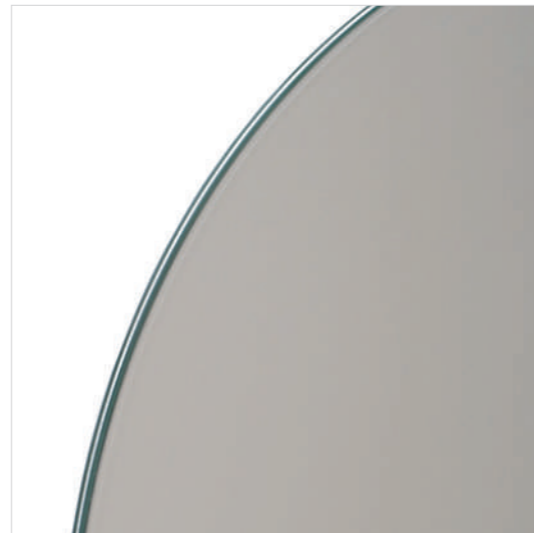
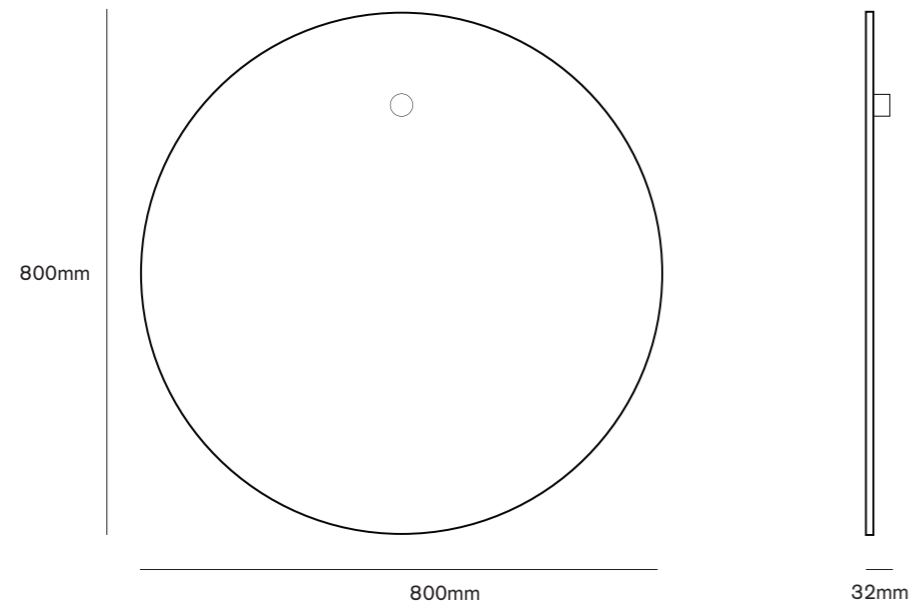

**COLLECTION 2020**  
**SPECIFICATION BOOKLET**

**PRODUCT**  
**HARPA MIRROR LARGE**

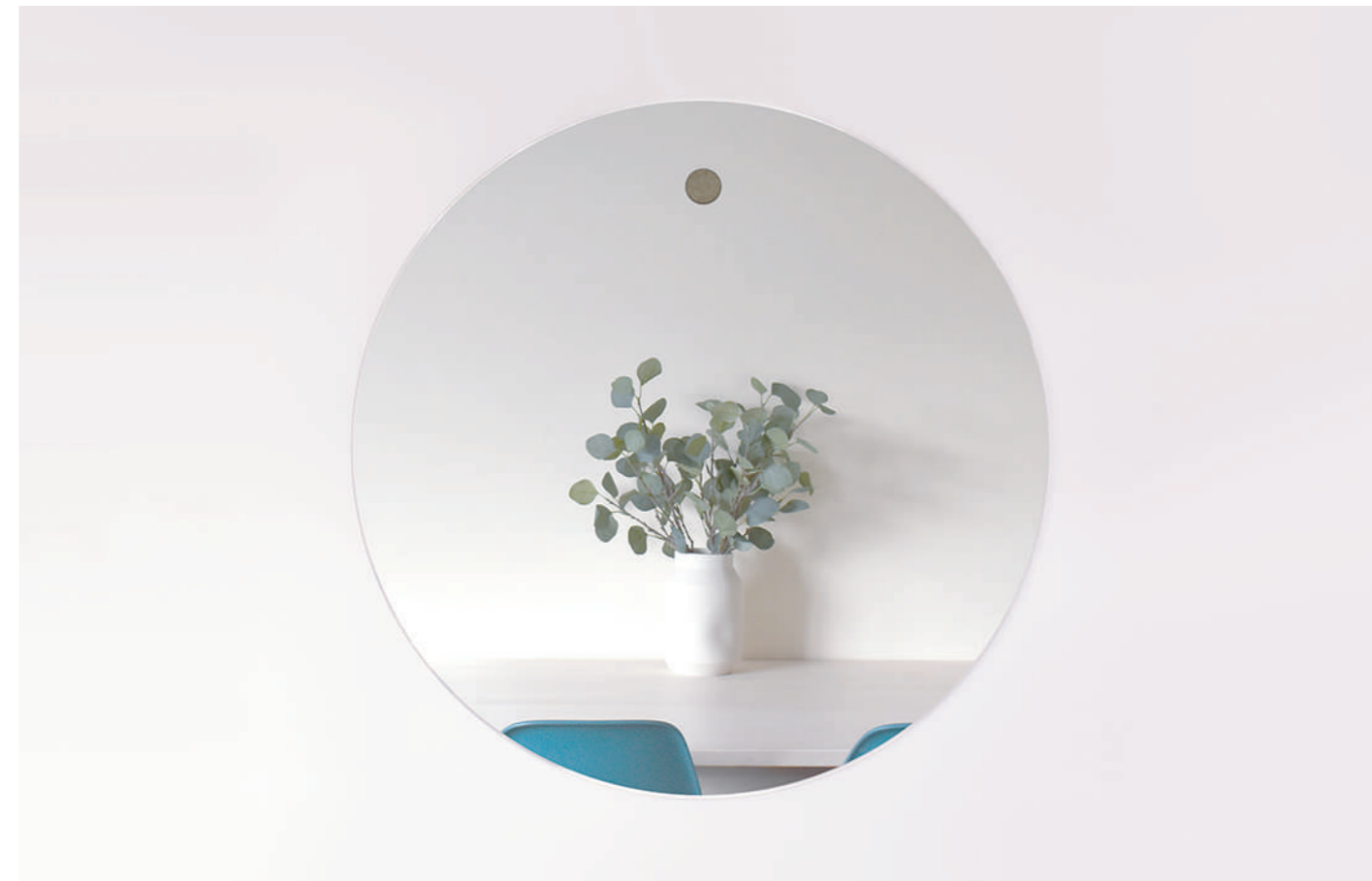

**PRODUCT INFORMATION**

**OPTIONS**

**CODE**

**DIMENSIONS (MM)**  
W800 x H800 x D32

**WEIGHT (KG)**  
8 (approx)

**MATERIALS**  
Mirrored Glass  
Ash/Walnut Dowel

**NOTE**  
\*Custom orders may be subject to a minimum quantity order. Please contact us to discuss.

**FINISH**

- Ash
- Walnut

**HAR-LA-ASH**

**HAR-LA-WAL**

**PRODUCT**  
**ATLAS SERIES BENCH**

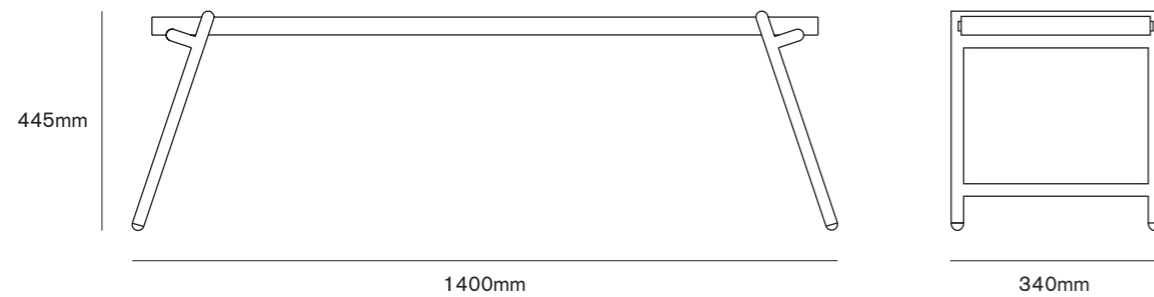

**COLLECTION 2020**  
**SPECIFICATION BOOKLET**

**PRODUCT**  
**ATLAS SERIES BENCH**



**PRODUCT INFORMATION**

**DIMENSIONS (MM)**  
W1400 x H445 x D37

**WEIGHT (KG)**  
10 (approx)

**MATERIALS**  
Steel  
Oak

**NOTE**  
\*Custom orders may be subject to a minimum quantity order. Please contact us to discuss.

**OPTIONS**

**COLOURS**

- |   |                          |           |
|---|--------------------------|-----------|
| ● | Traffic Black (RAL 9017) | AT-BE-TB  |
| ● | Graphite Grey (RAL 7024) | AT-BE-GG  |
| ● | Light Grey (RAL 7035)    | AT-BE-LG  |
| ○ | Traffic White (RAL 9016) | AT-BE-TW  |
| ● | Traffic Red (RAL 3020)   | AT-BE-TR  |
| ● | Raw Steel (Clear)        | AT-BE-RA  |
| ● | Custom RAL               | AT-BE-CUS |

**PRODUCT**  
**ATLAS SERIES TABLE**

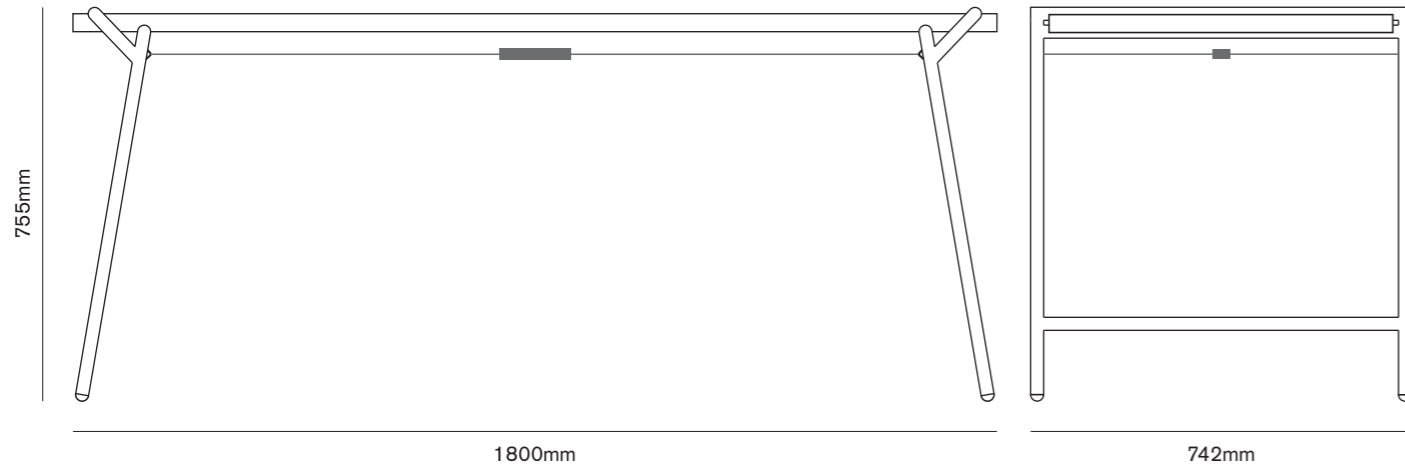

**COLLECTION 2020**  
**SPECIFICATION BOOKLET**

**PRODUCT**  
**ATLAS SERIES TABLE**



**PRODUCT INFORMATION**

**DIMENSIONS (MM)**  
W1800 x H757 x D742

**WEIGHT (KG)**  
18 (approx)

**MATERIALS**  
Steel  
Oak

**NOTE**  
\*Custom orders may be subject to a minimum quantity order. Please contact us to discuss.

**OPTIONS**

**COLOURS**

- Traffic Black (RAL 9017)**     **AT-TA-TB**
- Graphite Grey (RAL 7024)**     **AT-TA-GG**
- Light Grey (RAL 7035)**     **AT-TA-LG**
- Traffic White (RAL 9016)**     **AT-TA-TW**
- Traffic Red (RAL 3020)**     **AT-TA-TR**
- Raw Steel (Clear)**     **AT-TA-RA**
- Custom RAL**     **AT-TA-CUS**

**PRODUCT  
S2 CLOCK**

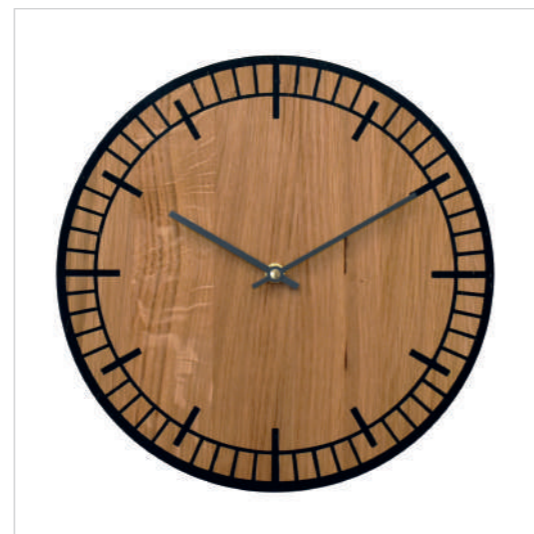
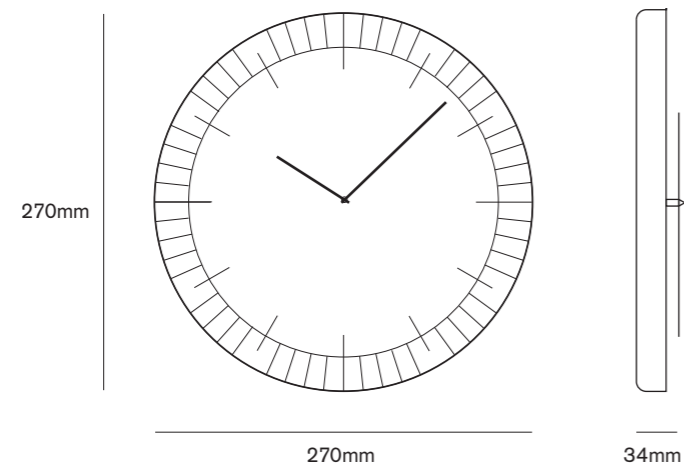

**COLLECTION 2020  
SPECIFICATION BOOKLET**

**PRODUCT  
S2 CLOCK**



**PRODUCT INFORMATION**

**DIMENSIONS (MM)**  
W270 x H270 x D34

**WEIGHT (KG)**  
1.5 (approx)

**MATERIALS**  
Oak

**NOTE**  
\*Custom orders may be subject to a minimum quantity order. Please contact us to discuss.

**OPTIONS**

**COLOURS**

-  **Black with grey hands** **S2-BL-G**
-  **Black with white hands** **S2-BL-W**
-  **White with grey hands** **S2-WH-G**
-  **White with white hands** **S2-WH-W**
-  **Grey with grey hands** **S2-GR-G**
-  **Grey with white hands** **S2-GR-W**
-  **Custom colour** **S2-CUS**

**CODE**

**PRODUCT**  
**RITUAL COIN TRAY**

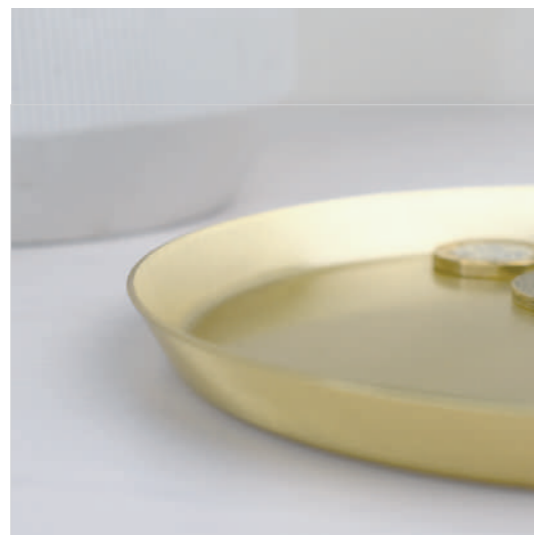
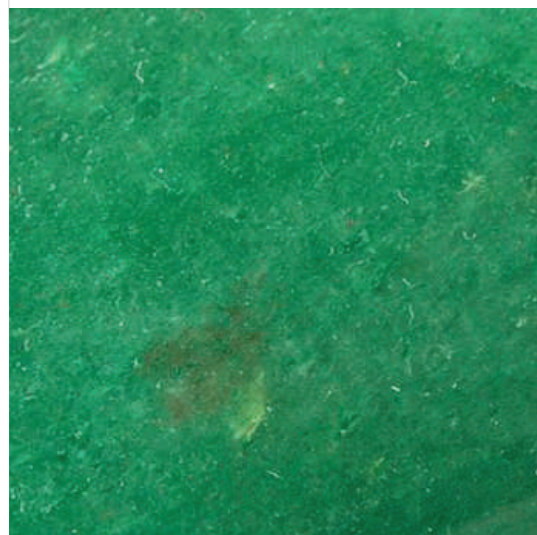
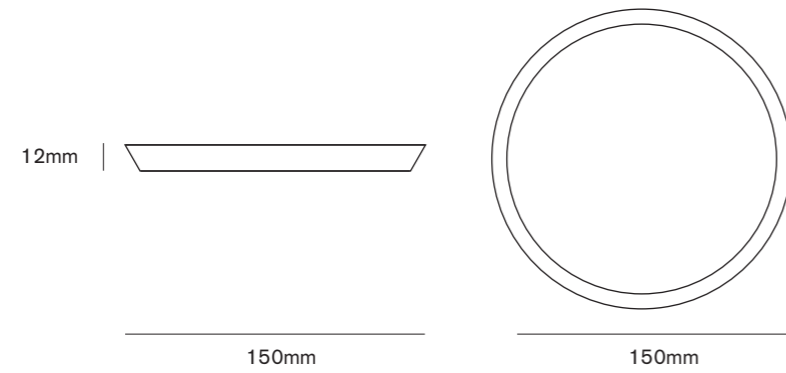

**COLLECTION 2020**  
**SPECIFICATION BOOKLET**

**PRODUCT**  
**RITUAL COIN TRAY**



**PRODUCT INFORMATION**

**OPTIONS**

**CODE**

**DIMENSIONS (MM)**  
W150 x H12 x D150

**WEIGHT (KG)**  
0.2 (approx)

**MATERIALS**  
Brass

**NOTE**  
\*Custom orders may be subject to a minimum quantity order. Please contact us to discuss.

**FINISH**

● Brass satin

**RIT-B-TRAY**

**PRODUCT**  
**RITUAL INCENSE BURNER**

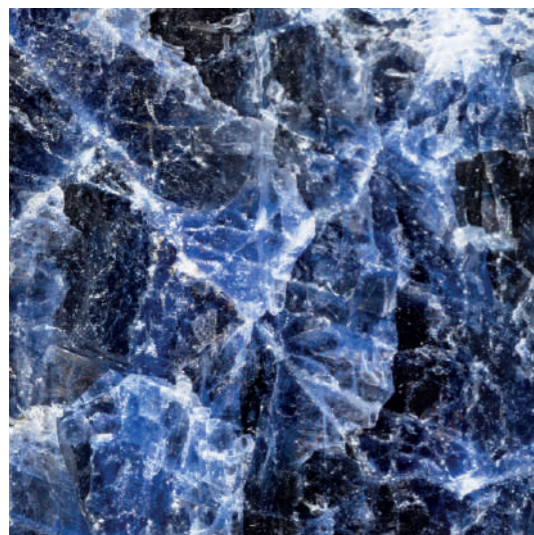
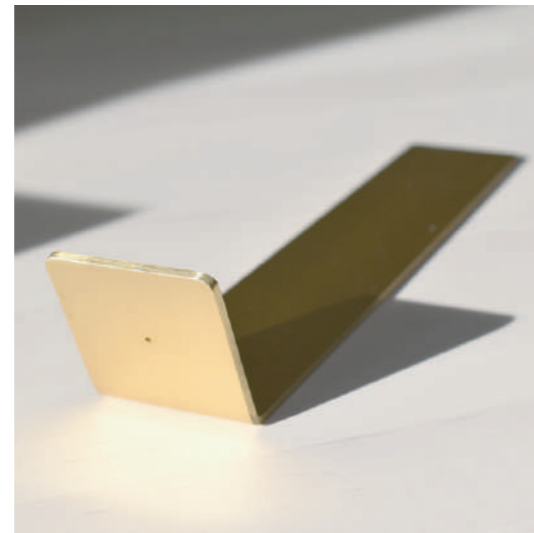
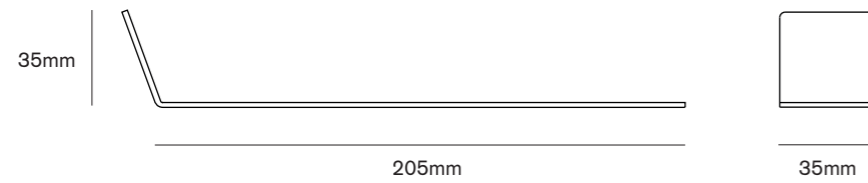

**COLLECTION 2020**  
**SPECIFICATION BOOKLET**

**PRODUCT**  
**RITUAL INCENSE BURNER**

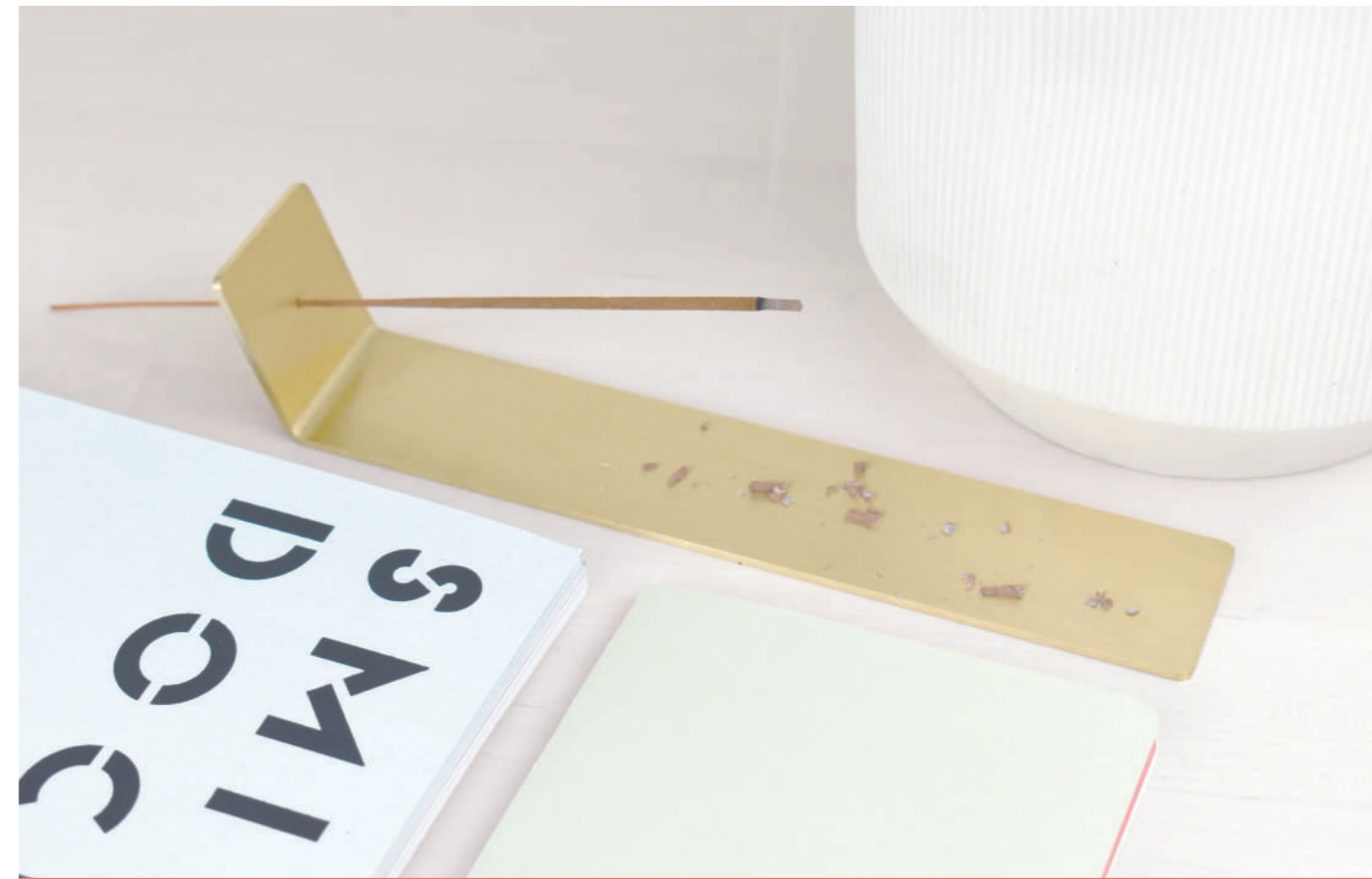

**PRODUCT INFORMATION**

**OPTIONS**

**CODE**

**DIMENSIONS (MM)**  
W205 x H35 x D35

**WEIGHT (KG)**  
0.2 (approx)

**MATERIALS**  
Brass

**NOTE**  
\*Custom orders may be subject to a minimum quantity order. Please contact us to discuss.

**FINISH**

● Brass satin

**RIT-B-INCE**



**PRODUCT  
RITUAL BOOKEND**

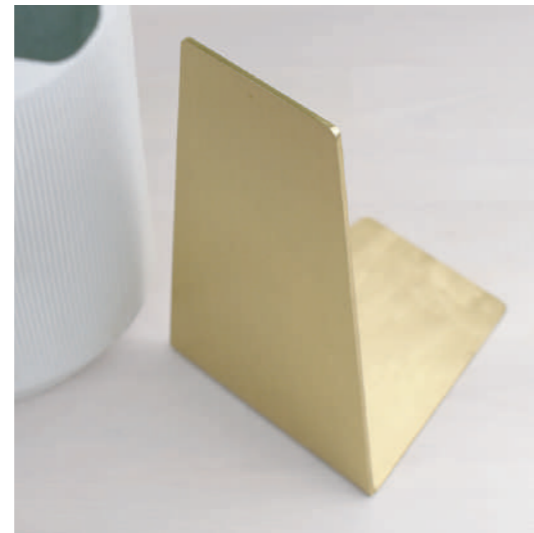
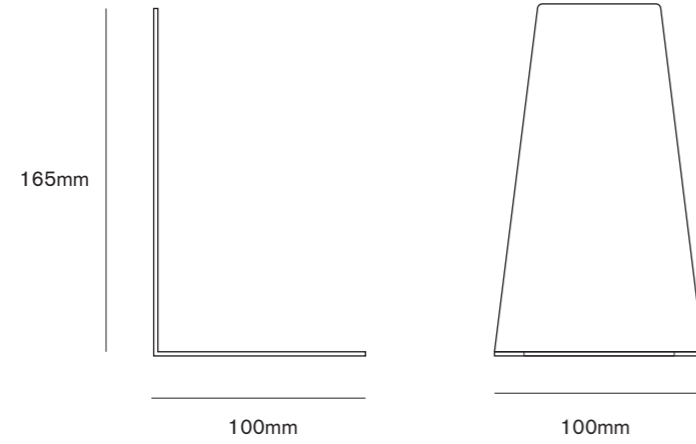

**COLLECTION 2020  
SPECIFICATION BOOKLET**

**PRODUCT  
RITUAL BOOKEND**



**PRODUCT INFORMATION**

**OPTIONS**

**CODE**

**DIMENSIONS (MM)**  
W72 x H165 x D100

**WEIGHT (KG)**  
0.3 (approx)

**MATERIALS**  
Brass

**FINISH**  
● Brass satin

**RIT-B-BOOK**

**NOTE**  
\*Custom orders may be subject to a minimum quantity order. Please contact us to discuss.

# Psalt.

[www.psaltdesign.com](http://www.psaltdesign.com)  
[hello@psaltdesign.com](mailto:hello@psaltdesign.com)